

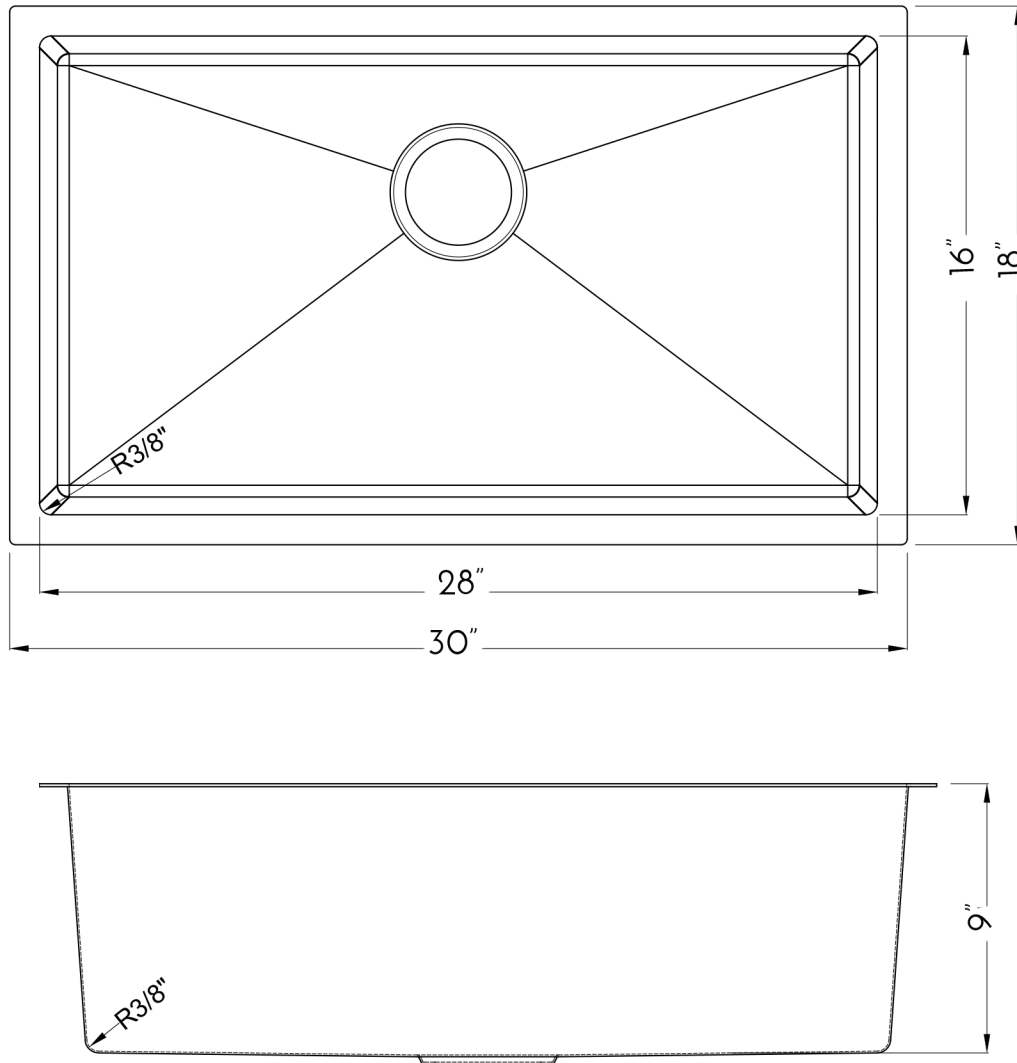

DAX-T3018-R10



UNDERMOUNT KITCHEN SINKS **SERIES**



FEATURES

- 304 Stainless Steel
- 18 Gauge
- Brushed Finish
- Single Bowl
- Sound Dampening
- Undermount Installation

ACCESSORIES

- Strainer not included (available)
- Bottom Grid not included (available)



KITCHEN SINK DAX-T3018-R10

OVER ALL SINK SIZE (in)	30" x 18" x 9"
INNER BASIN WIDTH (in)	16"
INNER BASIN LENGHT (in)	28"
LENGHT	30"
DEPTH	9"
WIDTH	18"
BOTTOM GRIDS INCLUDED	No
BASIN SPLIT	No
BASKET STRAINER INCLUDED	No
COLANDER INCLUDED	No
DRAIN CONNECTION	X
DRAIN PLACEMENT	Rear
FARM HOUSE	No
FAUCET HOLES	No
GAUGE	18g
INSTALATION TYPE	Undermount
MATERIAL	304 Stainless Steel
MINIMUM CABINET SIZE	X
MOUNTING HARDWARE INCLUDED	Yes
NUMBER OF BASINS	One
PRODUCT WEIGHT	14.99 lb
SINK SHAPE	Rectangular
SOUND DAMPENING	Yes
STAINLESS STEEL GRADE	304
UPC APPROVED	No
SINK FINISH TYPE	Brushed

For parts or sale requirements please contact our customer service department:



CS@daxib.com



1 888 685 8236